



SINCE 1976

SHOWFOU



GO

小金鋼

Peripheral pump

GMA

全自動水壓機

Peripheral Booster pump



SHOWFOU PUMP

PERIPHERAL PUMP — for household use

專利號碼 Patent # M279749



GO-0520P 1/2 HP x 3/4"
GO-0525P 1/2 HP x 1"



GO-125
1 HP x 1"

**Double Protection,
Higher Safety Operation**



GMA-0220P
1/4 HP x 3/4"



GMA-0525P
1/2 HP x 1"



GMA-125
1 HP x 1"

GO 小金鋼 Peripheral Pump

FEATURES 特點

- The main feature of this pump is to develop good pressure at low flows by using low-powered motors.
- Ideal for water supply and boosting applications, also machinery application such as welders and chillers.
- 1/2hp engineering plastic made pump casing guarantees complete hygiene and resistance against corrosion.
- 1hp cast iron made pump body with bronze insert to prevent rust from jamming the bronze alloy impeller.
- Equipped with the unique "loss of prime" pump protector to automatically cut-off power source when there is no water.
- Motor is equipped with overheat protection sensor.

PERFORMANCE CURVES 曲線圖

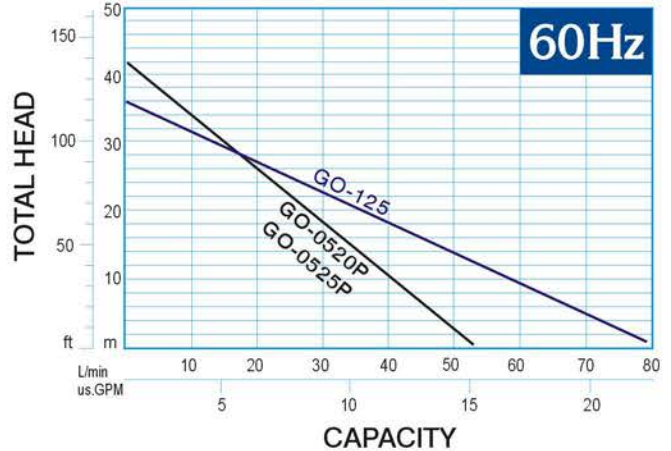
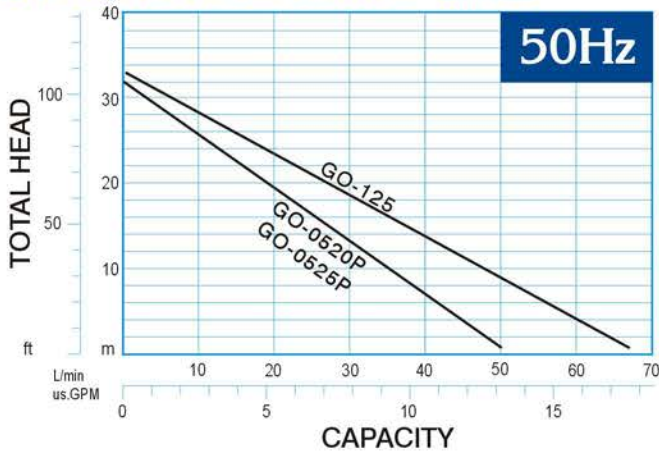

SPECIFICATIONS 規格表

Series 型式	MOTOR 電動機			口徑 Disch. Dia.	(50Hz) PUMP		(60Hz) PUMP		重量 Weight	DIMENSIONS 尺寸						
	Power		Phase		Volt	Max. Head	Max. Flow	Max. Head		Max. Flow	A	B	C	D	E	
	HP	kW	PH		V	M	L/min	M		L/min	mm	mm	mm	mm	mm	
GO-0520P	1/2	0.4	1	100-240	3/4	20	32	50	42	53	6.8	205	26	135	185	300
GO-0525P	1/2	0.4	1	100-240	1	25	32	50	42	53	6.8	205	26	135	185	300
GO-125	1	0.75	1	100-240	1	25	33	67	36	80	13	232	27	182	235	313

DIMENSIONS 尺寸圖

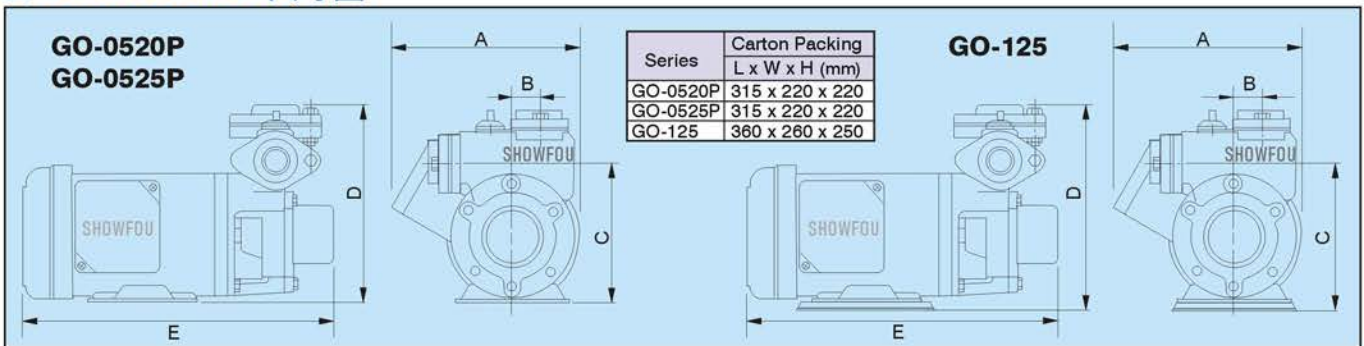

CONSTRUCTION 結構圖



GMA 全自動水壓機

Peripheral Booster Pump

PERFORMANCE CURVES 曲線圖

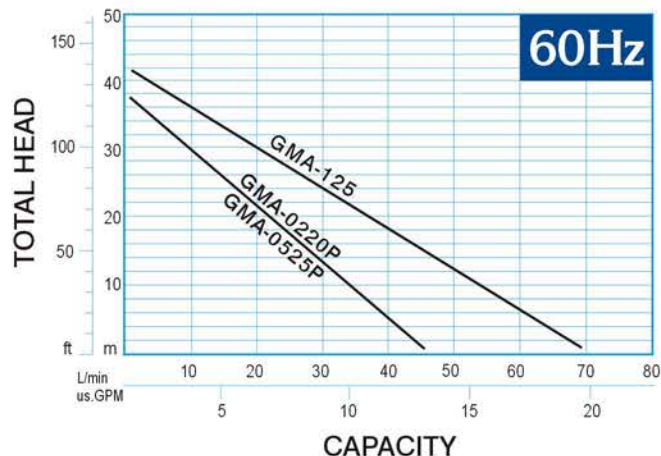
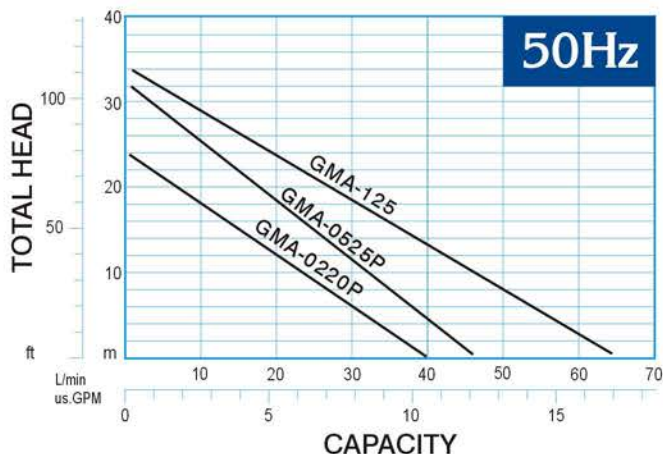

SPECIFICATIONS 規格表

Series 型式	MOTOR 電動機			口徑		(50Hz) PUMP				(60Hz) PUMP				重量 Weight kg	
	Power HP	Phase PH	Volt. V	Disch. Dia.		Max. Head M	Max. Flow L/min	Default Pressure Setting (kg/cm ²)		Max. Head M	Max. Flow L/min	Default Pressure Setting (kg/cm ²)			
				inch	mm			on	off			on	off		
GMA-0220P	1/4	0.2	1	100-240	3/4	20	24	40	0.8	1.8	38	45	1.4	2.4	8.4
GMA-0525P	1/2	0.4	1	100-240	1	25	32	45	1.4	2.4	38	45	2.0	3.0	8.4
GMA-125	1	0.75	1	100-240	1	25	34	63	1.8	2.8	42	70	2.5	3.5	16

CONSTRUCTION 結構圖

No.	NAME OF PARTS	MATERIAL	No.	NAME OF PARTS	MATERIAL
3	Motor Head Cover 馬達上蓋	Aluminum	31	Fan Cover 風葉蓋	Plastic
4	Capacitor 電容器		33	Pump Protector 水機開關	
7A	Upper Bearing 上軸承		34	Protector Cover 水機開關蓋	Plastic
7B	Lower Bearing 下軸承		35	Pressure Switch 壓力開關	
9	Coil+Stator 馬達線圈		39	Valve Cover 止水閥蓋	Plastic
10	Shaft+Rotor 主軸含轉子	Shaft: S45C	40	Spring 彈簧	Stainless Steel
13	Motor Casing 馬達中框	Steel	41	Check Valve 止水閥	Plastic
15	Mechanical Seal 機械軸封	Ceramic Carbon	45	Terminal Box Cover 電容器蓋	Plastic
16	Flange Setter 法蘭透	Cast Iron	60	Bolt 公頭螺絲	SS41
17	Motor Lower Cover 馬達下蓋	Aluminum+Plastic (for 0.25hp, 0.5hp) Cast Iron (1hp)	71	Square Ring 方形防洩圈	NBR
20	Pump Casing 水機	Plastic (for 0.25hp, 0.5hp) Cast Iron (1hp)	72A	Outlet Rubber 出口徑橡皮	NBR
21	Impeller 水葉	Bronze	72B	Outlet Rubber 出口徑橡皮	NBR
30	Cooling Fan 風葉	Plastic	90	Motor Base 馬達腳座	Plastic
			137	Pressure Tank Set 壓力桶組	SUS304
			190	Unequal Tee T形管	Plastic

DIMENSIONS 尺寸圖

Series	Carton Packing L x W x H (mm)		
	GMA-0220P	320	224
GMA-0525P	320	224	320
GMA-125	350	250	350

Series	DIMENSIONS (mm)				
	A	B	C	D	E
GMA-0220P	180	60	140	290	280
GMA-0525P	180	60	140	290	295
GMA-125	232	52	149	320	313

FEATURES : GMA 特點

- Compact design with stainless steel pressure tank for auto-water supply: tower water tank is not necessary.
- Pump with peripheral impeller capable of developing good pressure at low flows with low-powered consumption.
- Suitable for use with clean water that does not contain abrasive particles.
- 1/4 and 1/2hp engineering plastic made pump casing guarantees complete hygiene and resistance against corrosion.
- 1hp cast iron made pump casing with inserted bronze to prevent rust from jamming the impeller.
- Double protection (a "loss of prime" pump protection device plus an overheat motor protection sensor) for higher safety operation.



1hp GMA pump outlook

GMA pump installation example for sucking underground water or boosting tap water.

全自動水壓機 GMA 幫浦使用於自來水或地下水的地方

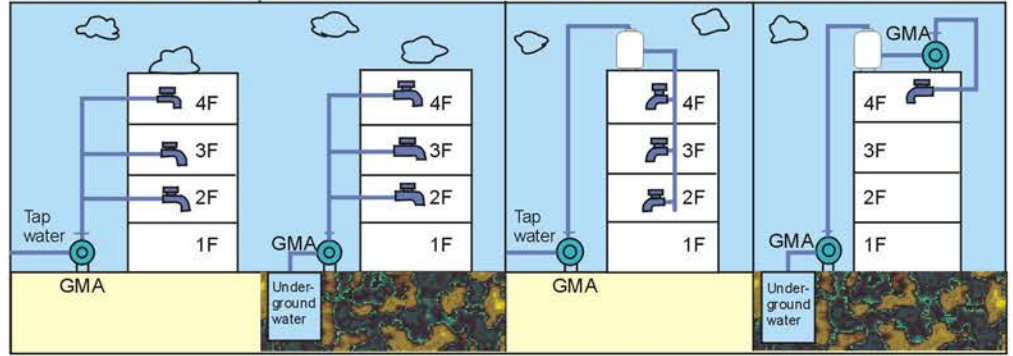

Installation examples for GMA 全自動水壓機 GMA 幫浦在各種不同的狀況下使用範例

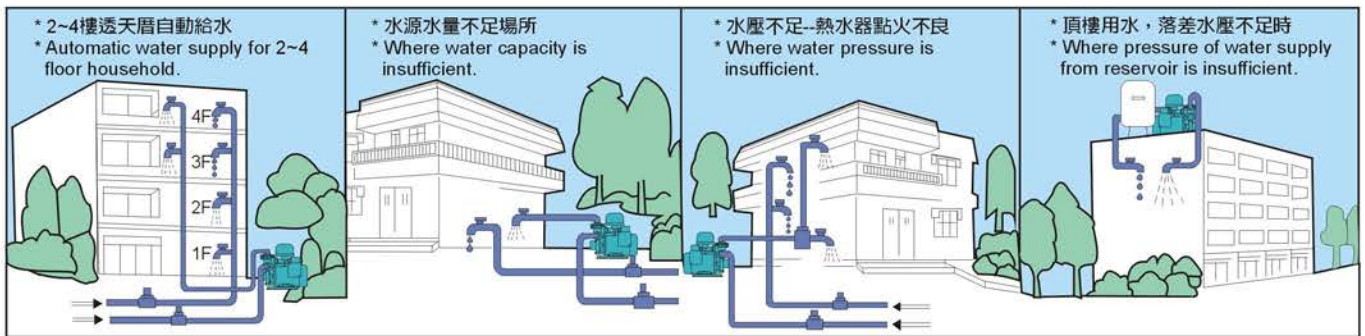

VARIOUS OPERATION APPLICATIONS FOR GO / GMA PUMPS

GO / GMA 幫浦在各種不同的狀況下使用範例

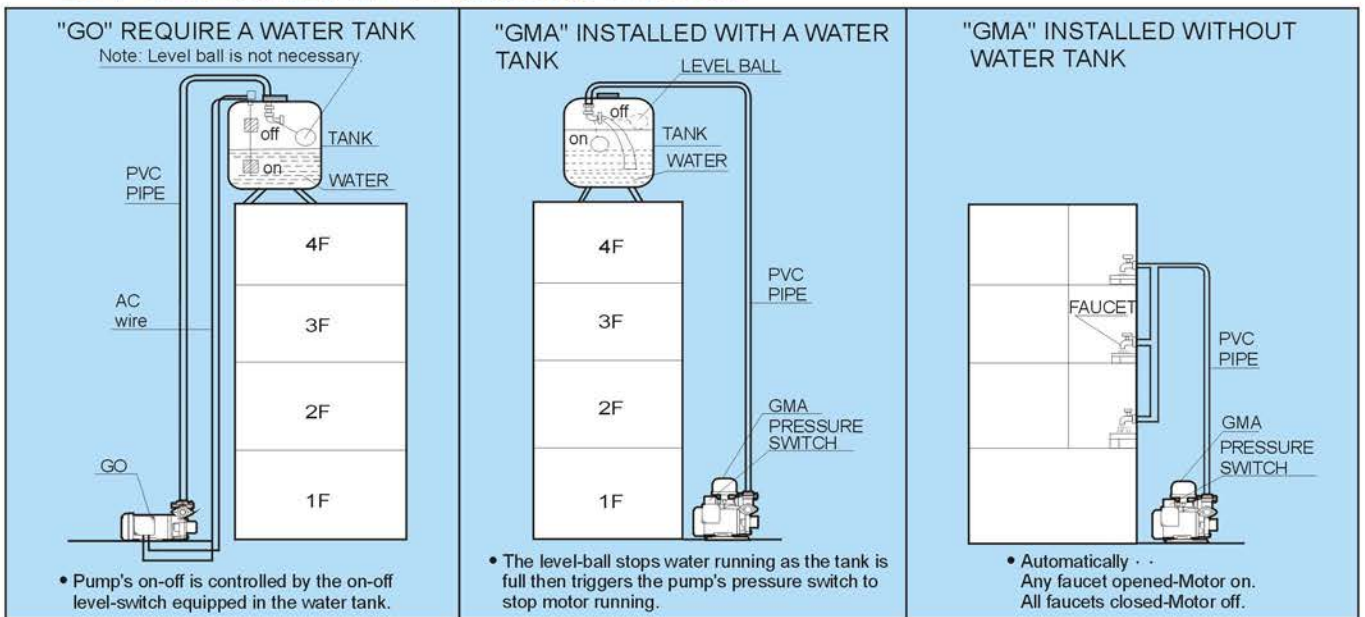

SHOWFOU ELECTRIC MACHINE CO., LTD.

66, Bengong Rd., Gangshan District, Kaohsiung City 82059, TAIWAN

修附電機股份有限公司

高雄市岡山區(82059)本工路66號
Tel : (07)6226590
Fax : +886-7-6226593



www.showfoupump.com

sales@showfou.com

All specifications subject to change without notice.